

CATALOG



HPB HALF PRICE BATHS COM
BATHROOMS - KITCHENS



Page 4 - 6: Intro

Page 7-12: Cabinet Styles

Page 13-16: Base Cabinets Specifications

Page 17-21: Wall Cabinets Specifications

Imagery courtesy of:
Ambiance Remodeling
Dakota Ridge Capital
AHI Construction
Interior Design Concepts
Sergiu Munteanu - HQ Homes
5 Rings Construction
Lujan Investment Group



Vanity Cabinets Specifications: [Page 22-25](#)

Accessories: [Page 26-29](#)

Limited Lifetime Warranty: [Page 30-31](#)

Price Index: [Page 32-39](#)

SHAKER CABINET FEATURES

5 Piece Door and Drawer Fronts.

*Painted doors are High Density Fiber (HDF).

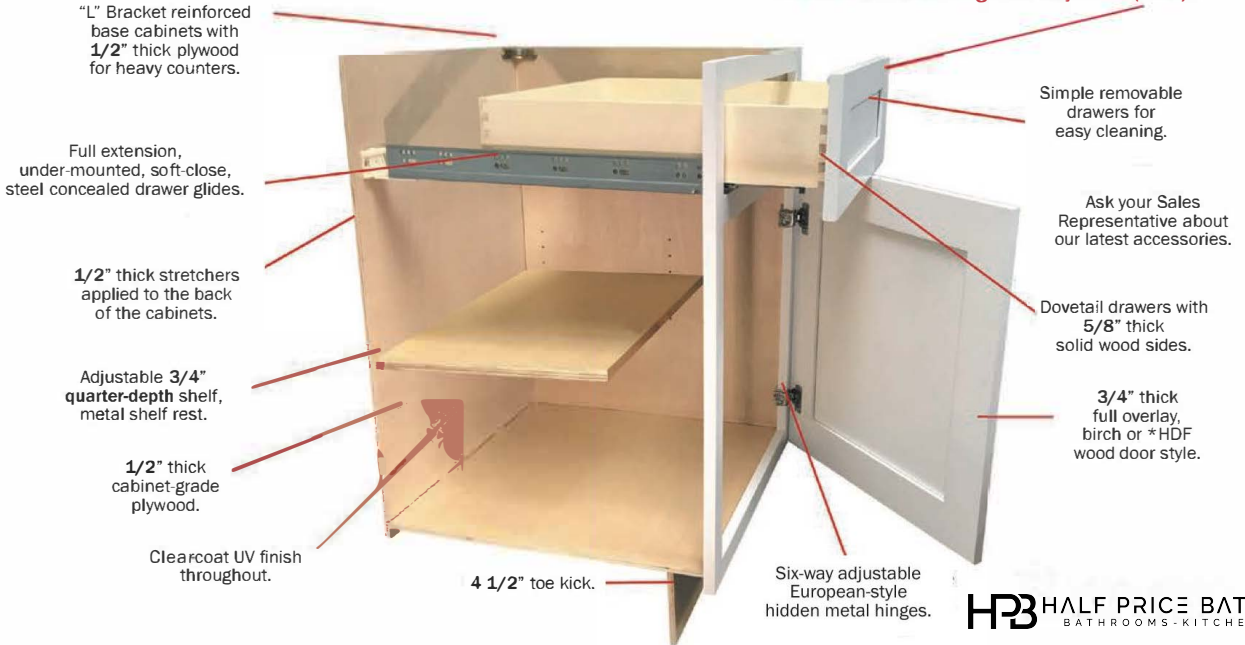

HPB HALF PRICE BATHS
BATHROOMS - KITCHENS

CABINET STYLES



Modern Slate Shaker



Grey Shaker



White Shaker



Espresso Shaker



NEW
Signature Blue Shaker



WHOLESALE CABINETS

WHITE SHAKER PAINTED

Wood: Painted or Stained, Birch, High Density Fiberboard (HDF)

Full overlay door panel, 3/4" thick door panel

Door Panel: Recessed door style, reversed raised door panel on the back

Painted surfaces are made of HDF.

Drawer: 5/8" thick cabinet grade plywood sides with full extension, under-mounted, soft-close, steel concealed drawer glides

Interior: Natural clear coat finish

Box: 1/2" thick cabinet grade plywood with metal L-bracket reinforcements for base cabinets

Hardware: 6-way adjustable 1 1/4" hinge with soft closing insert

Shelf: Quarter-depth, adjustable 3/4" thick cabinet grade plywood, metal shelf rests

Warranty: Limited Lifetime Warranty



WHOLESALE CABINETS
PAINTED **GREY SHAKER**



WHOLESALE CABINETS

ESPRESSO SHAKER STAIN



WHOLESALE CABINETS

STAIN MODERN SLATE SHAKER



WHOLESALE CABINETS
SIGNATURE BLUE PAINTED



BASE CABINETS



BASE CABINET

1 Door, 1 Drawer

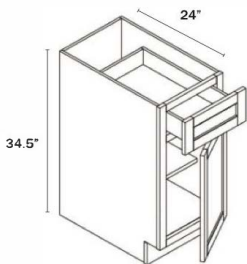

Name	Size	Wt
B09	9w x 34.5h x 24d	45 lb
B12	12w x 34.5h x 24d	48 lb
B15	15w x 34.5h x 24d	53 lb
B18	18w x 34.5h x 24d	56 lb
B21	21w x 34.5h x 24d	60 lb

BASE CABINET

2 Doors, 1 Drawer

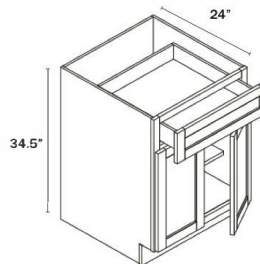

Name	Size	Wt
B24	24w x 34.5h x 24d	66 lb
B27	27w x 34.5h x 24d	71 lb
B30	30w x 34.5h x 24d	84 lb

BASE CABINET

2 Doors, 2 Drawers

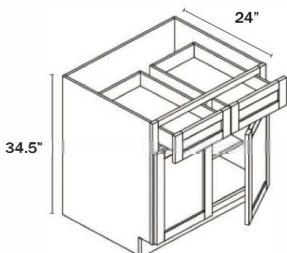

Name	Size	Wt
B33	33w x 34.5h x 24d	88 lb
B36	36w x 34.5h x 24d	92 lb
B42	42w x 34.5h x 24d	97 lb

3-DRAWER BASE CABINET*

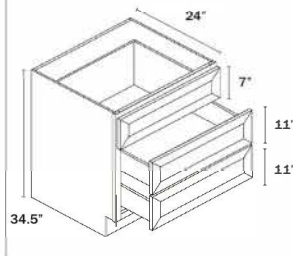

Name	Size	Wt
3DB12	12w x 34.5h x 24d	71 lb
3DB15	15w x 34.5h x 24d	79 lb
3DB18	18w x 34.5h x 24d	84 lb
3DB21	21w x 34.5h x 24d	89 lb
3DB24	24w x 34.5h x 24d	96 lb
3DB30	30w x 34.5h x 24d	106 lb
3DB36	36w x 34.5h x 24d	114 lb

*Utensil Drawers hold up to 30lbs, Large Base Drawers hold up to 75lbs.

2-DRAWER BASE CABINET

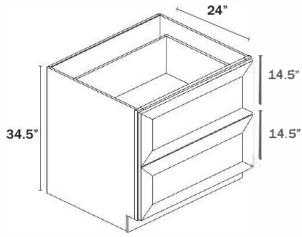

Name	Size	Wt
2DB24	24w x 34.5h x 24d	86 lb
2DB30	30w x 34.5h x 24d	96 lb
2DB36	36w x 34.5h x 24d	107 lb

*Utensil Drawers hold up to 30lbs, Large Base Drawers hold up to 75lbs.

BASE CABINET FULL HEIGHT DOOR

1 Door

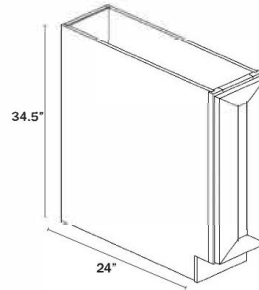

Name	Size	Wt
B09FHD	9w x 34.5h x 24d	45 lb

BASE CABINET FULL HEIGHT DOOR

2 Doors

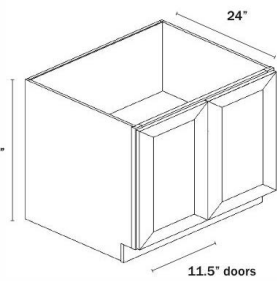

Name	Size	Wt
B24FHD	24w x 34.5h x 24d	66 lb

SINK BASE CABINET

2 Doors, 1 False Drawer

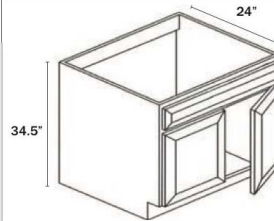

Name	Size	Wt
SB24	24w x 34.5h x 24d	47 lb
SB27	27w x 34.5h x 24d	51 lb
SB30	30w x 34.5h x 24d	52 lb
SB33	33w x 34.5h x 24d	53 lb

SINK BASE CABINET

2 Doors, 2 False Drawers

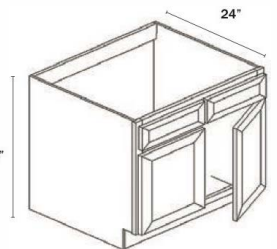

Name	Size	Wt
SB36	36w x 34.5h x 24d	57 lb
SB42	42w x 34.5h x 24d	62 lb

CORNER SINK BASE CABINET

1 Door

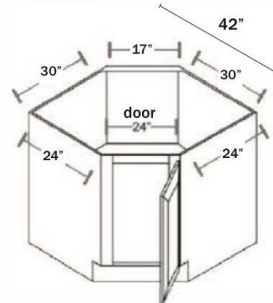

Name	Size	Wt
CSB42	42w x 34.5h x 24d	72 lb

FARM HOUSE SINK BASE CABINET

2 Doors

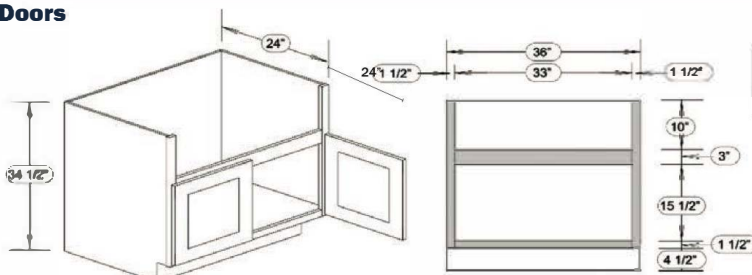

Name	Size	Wt
FSM36	36w x 34.5h x 24d	57 lb

Extra fillers may be needed to frame the apron/front of the sink; sink sizes vary.

18"W x 18"H Doors.

BASE LAZY SUSAN CABINET

2 Doors

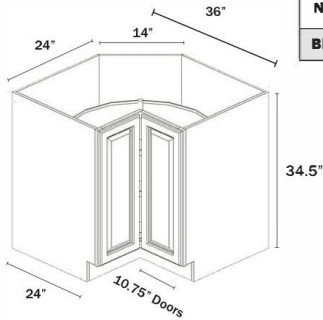

Name	Size	Wt
BLS36	36w x 34.5h x 24d	113 lb

BLS36 Door width - 10 3/4"

BLIND CORNER BASE CABINET

1 Door, 1 Drawer

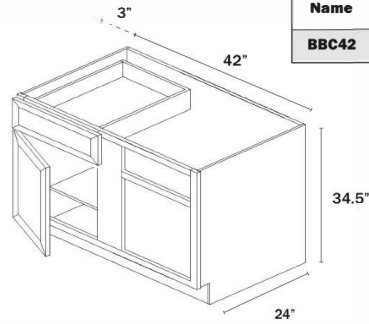

Name	Size	Wt
BBC42	42w x 34.5h x 24d	81 lb

Specify left or right
Minimum 3" pull from the wall

Door & Drawer width - 18"

BASE END CORNER CABINET

2 Doors, 2 False Fronts

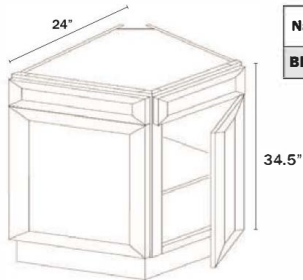

Name	Size	Wt
BEC24	24w x 34.5h x 24d	51 lb

Two 18 5/8" doors.

BASE END SHELF CABINET

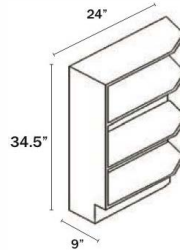

Name	Size	WT
BES09	9w x 34.5h x 24d	37 lb

Specify left or right.
Two-piece, Shelf and Toe-kick.

BASE TRASH CABINET

1 Door, 1 Drawer

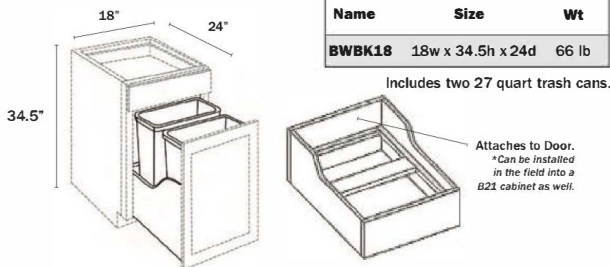

Name	Size	Wt
BWBK18	18w x 34.5h x 24d	66 lb

Includes two 27 quart trash cans.

Attaches to Door.
*Can be installed in the field into a B21 cabinet as well.

BASE SPICE RACK CABINET

1 Door

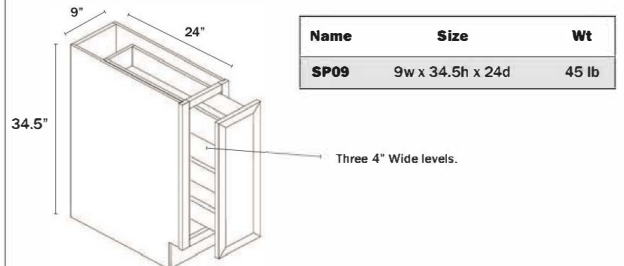

Name	Size	Wt
SP09	9w x 34.5h x 24d	45 lb

Three 4" Wide levels.

BASE SPICE DRAWERS CABINET

5 Drawers

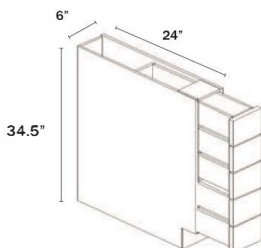

Name	Size	Wt
BWRC6	6w x 34.5h x 24d	59 lb

No soft close.
No drawer guides.



TALL PANTRY CABINET

2 Doors

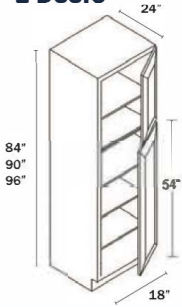

Name	Size	Wt
PC188424	18w x 84h x 24d	145 lb
PC189024	18w x 90h x 24d	152 lb
PC189624	18w x 96h x 24d	158 lb

Comes with shelves only.
Roll Out Tray upgrade optional, see Accessories.

TALL PANTRY CABINET

4 Doors

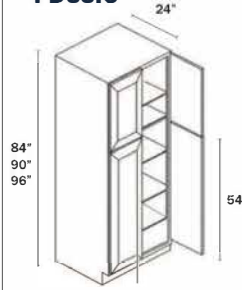

Name	Size	Wt
PC248424	24w x 84h x 24d	160 lb
PC249024	24w x 90h x 24d	171 lb
PC249624	24w x 96h x 24d	183 lb
PC308424	30w x 84h x 24d	180 lb
PC309024	30w x 90h x 24d	191 lb
PC309624	30w x 96h x 24d	206 lb

Comes with shelves only.
Roll Out Tray upgrade optional, see Accessories.

TALL OVEN CABINET: 2 Doors, 1 or 3 bottom drawers

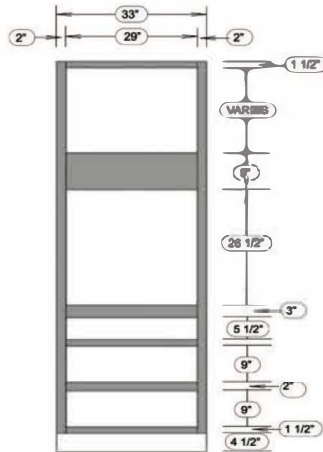
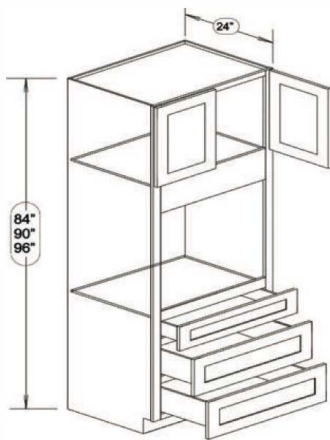

Name	Size	Wt
OC338424	33w x 84h x 24d	153 lb
OC339024	33w x 90h x 24d	165 lb
OC339624	33w x 96h x 24d	175 lb

Will work for single oven, Oven/Microwave Combo or double oven. One bottom drawer remains for double oven & Oven/Microwave configuration (divider will need to be cut).

Extra Trim piece(s) may be needed.

Additional modification charge(s) may apply.



WALL CABINETS



WALL CABINET 12" HIGH

2 Doors

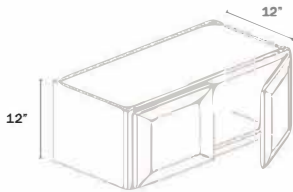

Name	Size	Wt
W3012	30w x 12h x 12d	23 lb
W3312	33w x 12h x 12d	25 lb
W3612	36w x 12h x 12d	26 lb

WALL CABINET 15" HIGH

1 Door

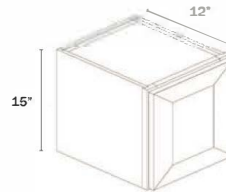

Name	Size	Wt
W1515	15w x 15h x 12d	16 lb
W1815	18w x 15h x 12d	19 lb
W2115	21w x 15h x 12d	21 lb

Specify left or right hinge

WALL CABINET 15" HIGH

2 Doors



Name	Size	Wt
W2415	24w x 15h x 12d	23 lb
W2715	27w x 15h x 12d	25 lb
W3015	30w x 15h x 12d	27 lb
W3315	33w x 15h x 12d	28 lb
W3615	36w x 15h x 12d	30 lb

WALL CABINET 18" HIGH

2 Doors

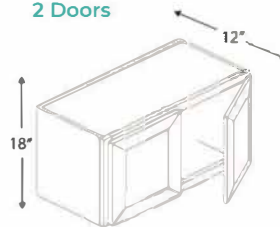

Name	Size	Wt
W3018	30w x 18h x 12d	29 lb
W3318	33w x 18h x 12d	31 lb
W3618	36w x 18h x 12d	33 lb

WALL CABINET 21" HIGH

2 Doors

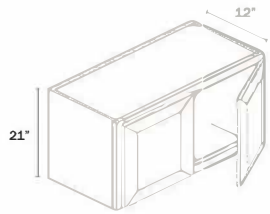

Name	Size	Wt
W3021	30w x 21h x 12d	32 lb
W3321	33w x 21h x 12d	34 lb
W3621	36w x 21h x 12d	39 lb

No center style.

WALL CABINET 24" HIGH

2 Doors

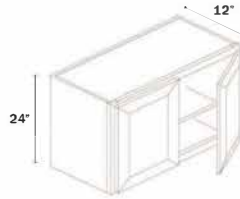

Name	Size	Wt
W3024	30w x 24h x 12d	39 lb
W3324	33w x 24h x 12d	43 lb
W3624	36w x 24h x 12d	44 lb

No center style.

WALL CABINET 30" HIGH

1 Door

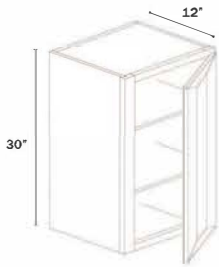

Name	Size	Wt
W0930	09w x 30h x 12d	23 lb
W1230	12w x 30h x 12d	26 lb
W1530	15w x 30h x 12d	30 lb
W1830	18w x 30h x 12d	33 lb
W2130	21w x 30h x 12d	35 lb

Specify left or right hinge.

WALL CABINET 30" HIGH

2 Doors

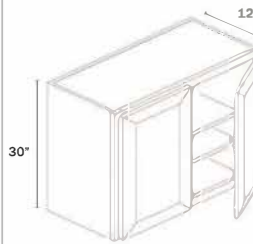

Name	Size	Wt
W2430	24w x 30h x 12d	38 lb
W2730	27w x 30h x 12d	45 lb
W3030	30w x 30h x 12d	49 lb
W3330	33w x 30h x 12d	53 lb
W3630	36w x 30h x 12d	55 lb
W4230	42w x 30h x 12d	63 lb

No center style.

WALL CABINET 36" HIGH

1 Door

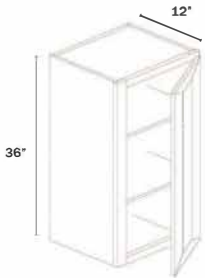

Name	Size	Wt
W0936	09w x 36h x 12d	26 lb
W1236	12w x 36h x 12d	30 lb
W1536	15w x 36h x 12d	32 lb
W1836	18w x 36h x 12d	37 lb
W2136	21w x 36h x 12d	41 lb

Specify left or right hinge.

WALL CABINET 36" HIGH

2 Doors

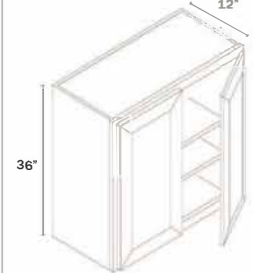

Name	Size	Wt
W2436	24w x 36h x 12d	46 lb
W2736	27w x 36h x 12d	48 lb
W3036	30w x 36h x 12d	54 lb
W3336	33w x 36h x 12d	58 lb
W3636	36w x 36h x 12d	62 lb
W4236	42w x 36h x 12d	69 lb

No center style.

WALL CABINET 42" HIGH

1 Door



Name	Size	Wt
W0942	09w x 42h x 12d	30 lb
W1242	12w x 42h x 12d	34 lb
W1542	15w x 42h x 12d	37 lb
W1842	18w x 42h x 12d	42 lb
W2142	21w x 42h x 12d	46 lb

Specify left or right hinge.

WALL CABINET 42" HIGH

2 Doors

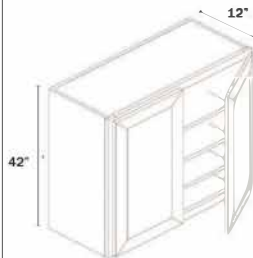

Name	Size	Wt
W2442	24w x 42h x 12d	52 lb
W2742	27w x 42h x 12d	58 lb
W3042	30w x 42h x 12d	63 lb
W3342	33w x 42h x 12d	66 lb
W3642	36w x 42h x 12d	72 lb
W4242	42w x 42h x 12d	81 lb

No center style.

WALL FRIDGE CABINET

2 Doors

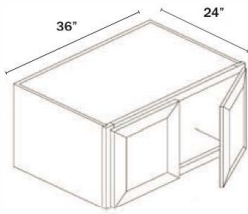

Name	Size	Wt
W361224	36w x 12h x 24d	33 lb
W361524	36w x 15h x 24d	38 lb
W361824	36w x 18h x 24d	39 lb
W362124	36w x 21h x 24d	50 lb
W362424	36w x 24h x 24d	67 lb

WALL BLIND CORNER CABINET

1 Door

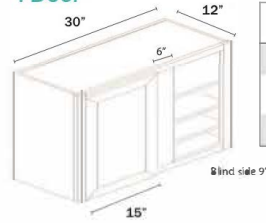

Name	Size	Wt
WBC3030	30w x 30h x 12d	44 lb
WBC3036	30w x 36h x 12d	50 lb
WBC3042	30w x 42h x 12d	57 lb

Door is 15" wide
Specify left or right

WALL DIAGONAL CORNER 24" Wide

1 Door

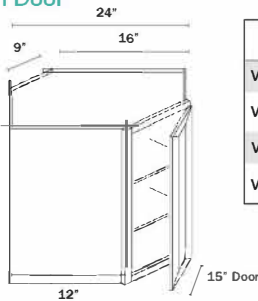

Name	Size	Wt
WDC2415	24w x 15h x 12d	31 lb
WDC2430	24w x 30h x 12d	58 lb
WDC2436	24w x 36h x 12d	64 lb
WDC2442	24w x 42h x 12d	75 lb

WALL DIAGONAL CORNER 27" Wide

1 Door

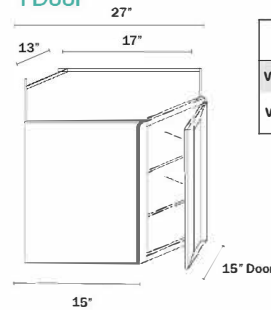

Name	Size	Wt
WDC273615	27w x 36h x 15d	77 lb
WDC274215	27w x 42h x 15d	90 lb

WALL EASY REACH CABINET

2 Doors

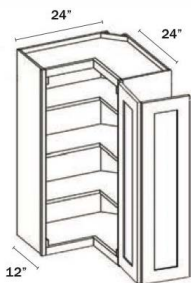

Name	Size	Wt
WLS2430	24w x 30h x 12d	60 lb
WLS2436	24w x 36h x 12d	67 lb
WLS2442	24w x 42h x 12d	79 lb

Shelves only.

WALL MICROWAVE CABINET

2 Doors

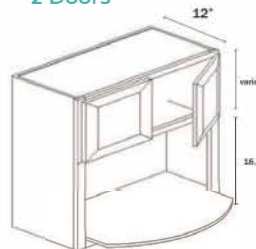

Name	Size	Wt
WMC2730	27w x 30h x 12d	39 lb
WMC2736	27w x 36h x 12d	45 lb
WMC2742	27w x 42h x 12d	49 lb
WMC3030	30w x 30h x 12d	49 lb
WMC3036	30w x 36h x 12d	55 lb
WMC3042	30w x 42h x 12d	59 lb

Interior opening height 16 1/2"
Max appliance width, subtract 3" from cabinet width

WALL END SHELVES

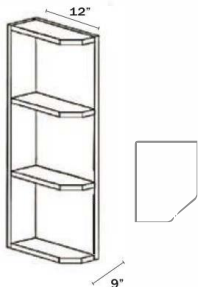

Name	Size	Wt
WES0930	09w x 30h x 12d	19 lb
WES0936	09w x 36h x 12d	20 lb
WES0942	09w x 42h x 12d	24 lb

Specify left or right.
Finished shelves.

WALL END CABINET

2 Doors



Name	Size	Wt
WEC1230	12w x 30h x 12d	26 lb
WEC1236	12w x 36h x 12d	30 lb
WEC1242	12w x 42h x 12d	42 lb

WALL WINE RACK

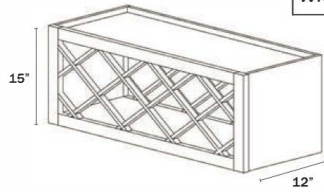

Name	Size	Wt
WRC3015	30w x 15h x 12d	25 lb
WRC3615	36w x 15h x 12d	28 lb

Can be used vertical.

WALL GLASS RACK

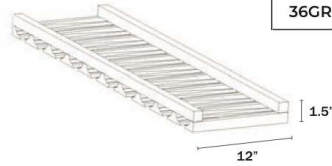

Name	Size	Wt
30GR	30w x 1.5h x 12d	7 lb
36GR	36w x 1.5h x 12d	7 lb

Attaches under cabinet.

WALL GLASS CABINET 15" HIGH

1 Door

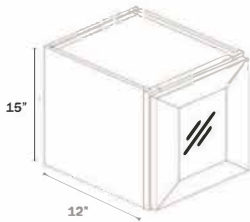

Name	Size	Wt
W1515GD	15w x 15h x 12d	15 lb
W1815GD	18w x 15h x 12d	18 lb
W2115GD	21w x 15h x 12d	20 lb

Frosted glass.
Finished interior is an upgrade option.
Specify left or right hinge.

WALL GLASS CABINET 15" HIGH

2 Doors

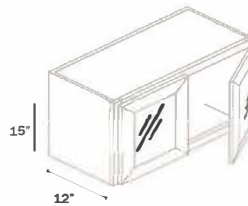

Name	Size	Wt
W2415GD	24w x 15h x 12d	23 lb
W2715GD	27w x 15h x 12d	25 lb
W3015GD	30w x 15h x 12d	28 lb
W3315GD	33w x 15h x 12d	28 lb
W3615GD	36w x 15h x 12d	31 lb

Frosted glass.
Finished interior is an upgrade option.
No center style.

WALL GLASS CABINET 30" HIGH

1 Door

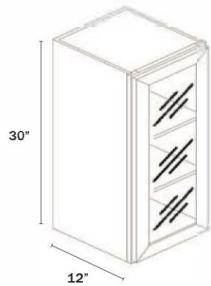

Name	Size	Wt
W1530GD	15w x 30h x 12d	30 lb
W1830GD	18w x 30h x 12d	34 lb

Frosted glass.
Finished interior is an upgrade option.
Specify left or right hinge.

WALL GLASS CABINET 30" HIGH

2 Doors

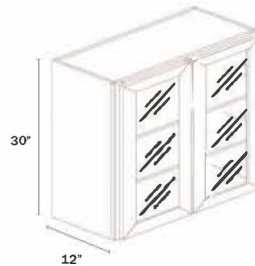

Name	Size	Wt
W2430GD	24w x 30h x 12d	40 lb
W3030GD	30w x 30h x 12d	50 lb
W3630GD	36w x 30h x 12d	60 lb

Frosted glass.
Finished interior is an upgrade option.
No center style.

WALL GLASS CABINET 36" HIGH

1 Door

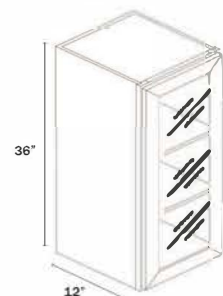

Name	Size	Wt
W1536GD	15w x 36h x 12d	14 lb
W1836GD	18w x 36h x 12d	14 lb

Frosted glass.
Finished interior is an upgrade option.
Specify left or right hinge.

WALL GLASS CABINET 36" HIGH

2 Doors

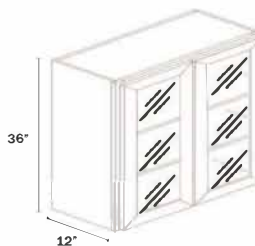

Name	Size	Wt
W2436GD	24w x 36h x 12d	50 lb
W3036GD	30w x 36h x 12d	58 lb
W3636GD	36w x 36h x 12d	66 lb

Frosted glass.
Finished interior is an upgrade option.
No center style.

WALL GLASS CABINET 42" HIGH

1 Door



Name	Size	Wt
W1542GD	15w x 42h x 12d	44 lb
W1842GD	18w x 42h x 12d	61 lb

Frosted glass.
Finished interior is an upgrade option.

WALL GLASS CABINET 42" HIGH

2 Doors



Name	Size	Wt
W2442GD	24w x 42h x 12d	66 lb
W3042GD	30w x 42h x 12d	72 lb
W3642GD	36w x 42h x 12d	79 lb

Frosted glass.
Finished interior is an upgrade option.

WALL DIAGONAL GLASS CORNER 24" Wide

1 Door

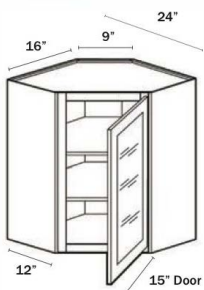

Name	Size	Wt
WDC2415GD	24w x 15h x 12d	31 lb
WDC2430GD	24w x 30h x 12d	64 lb
WDC2436GD	24w x 36h x 12d	70 lb
WDC2442GD	24w x 42h x 12d	80 lb

Frosted glass.
Finished interior is an upgrade option.
Door width 15".

WALL DIAGONAL GLASS CORNER 27" Wide

1 Door

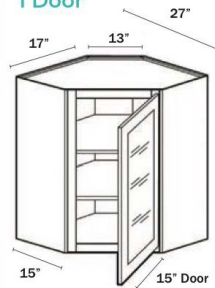

Name	Size	Wt
WDC273615GD	27w x 36h x 15d	82 lb
WDC274215GD	27w x 42h x 15d	100 lb

Frosted glass.
Finished interior is an upgrade option.
Door width 15".



VANITY CABINETS



VANITY SINK BASE CABINET

2 Doors, 1 False Drawer

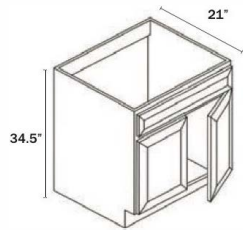

Name	Size	Wt
VSB2421	24w x 34.5h x 21d	42 lb
VSB2721	27w x 34.5h x 21d	45 lb
VSB3021	30w x 34.5h x 21d	48 lb
VSB3621	36w x 34.5h x 21d	54 lb

VANITY DRAWER BASE CABINET

3 Drawers

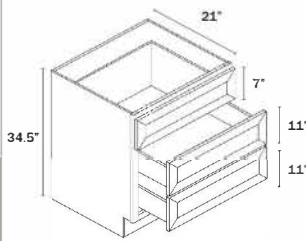

Name	Size	Wt
VDB12	12w x 34.5h x 21d	69 lb
VDB15	15w x 34.5h x 21d	74 lb
VDB18	18w x 34.5h x 21d	81 lb
VDB21	21w x 34.5h x 21d	86 lb
VDB24	24w x 34.5h x 21d	94 lb

VANITY SINK BASE CABINET

1 Door, 1 Drawer

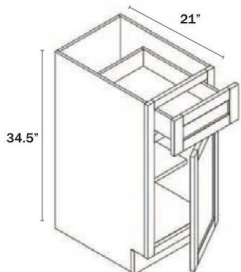

Name	Size	Wt
VB09	9w x 34.5h x 21d	35 lb
VB12	12w x 34.5h x 21d	47 lb
VB15	15w x 34.5h x 21d	50 lb
VB18	18w x 34.5h x 21d	56 lb

VANITY KNEE DRAWER

1 Drawer

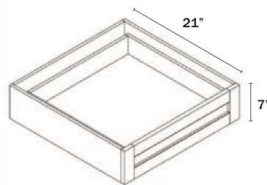

Name	Size	Wt
KD24	24w x 7h x 21d	29 lb
KD30	30w x 7h x 21d	34 lb
KD36	36w x 7h x 21d	39 lb

Commonly used as a desk drawer or an additional stacked drawer

VANITY SINK BASE COMBO 42"

1 Drawer Left, 1 Drawer Right, Sink Centered

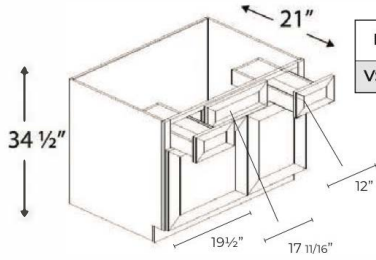

Name	Size	Wt
VSD4221	42w x 34.5h x 21d	88 lb

Two deep 12" wide drawers.
No center style.
Full back.

VANITY SINK BASE COMBO 48"/60"

3 Drawers Left, 3 Drawers Right, Sink Centered

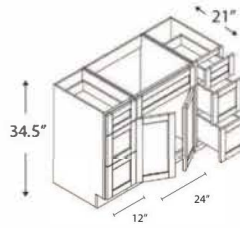

Name	Size	Wt
VSD4821D	48w x 34.5h x 21d 12" wide drawers	145 lb
VSD6021D	60w x 34.5h x 21d 15" wide drawers	164 lb

Six deep 12" wide drawers.
No center style.
Sink centered.

VANITY SINK BASE COMBO 60"

3 Drawers Middle, Double Sink

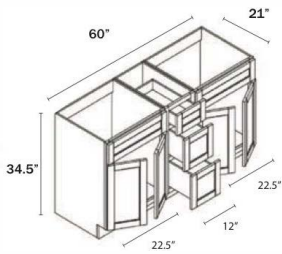

Name	Size	Wt
VSD6021DD	60w x 34.5h x 21d	120 lb

Three deep 12" wide drawers.
No center styles.

VANITY SINK BASE COMBO CABINET 30"

1 Door, 2 Drawers

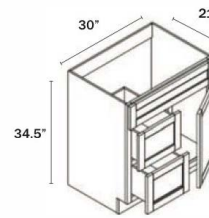

DL=Drawers Left

OR

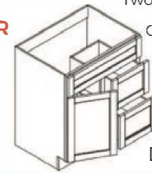

DR=Drawers Right

Name	Size	Wt
VSD3021DL	30w x 34.5h x 21d	79 lb
VSD3021DR	30w x 34.5h x 21d	79 lb

Two deep 12" wide drawers.
Centered sink, one door.
Full back.

VANITY SINK BASE COMBO CABINET 36"

2 Doors, 2 Drawers

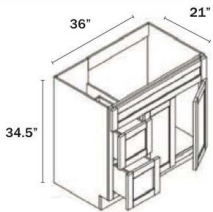

DL=Drawers Left

OR

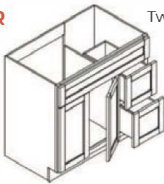

DR=Drawers Right

Name	Size	Wt
VSD3621DL	36w x 34.5h x 21d	87 lb
VSD3621DR	36w x 34.5h x 21d	87 lb

Two deep 12" wide drawers.
Centered sink, 2 doors.
No center style.
Full back.

VANITY COUNTERTOP LINEN CABINET

1 Door, 2 Drawers

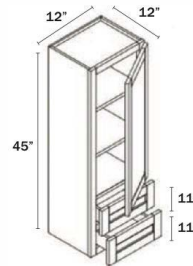

Name	Size	Wt
DV1245	12w x 45h x 12d	45 lb

Designed to be put on top of counter.

VANITY LINEN CABINET

1 Door, 3 Drawers

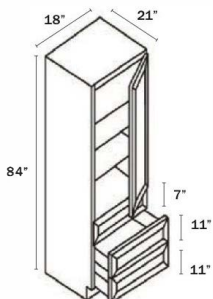

Name	Size	Wt
SVA188421	18w x 84h x 21d	149 lb



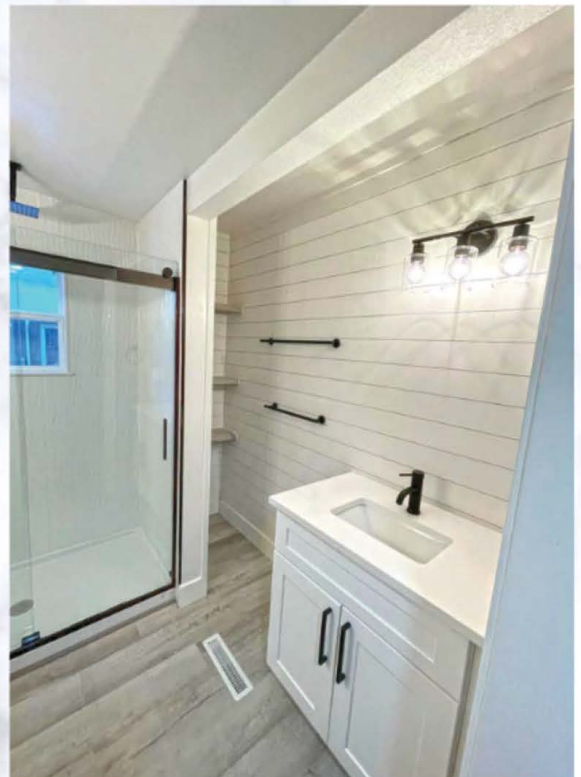

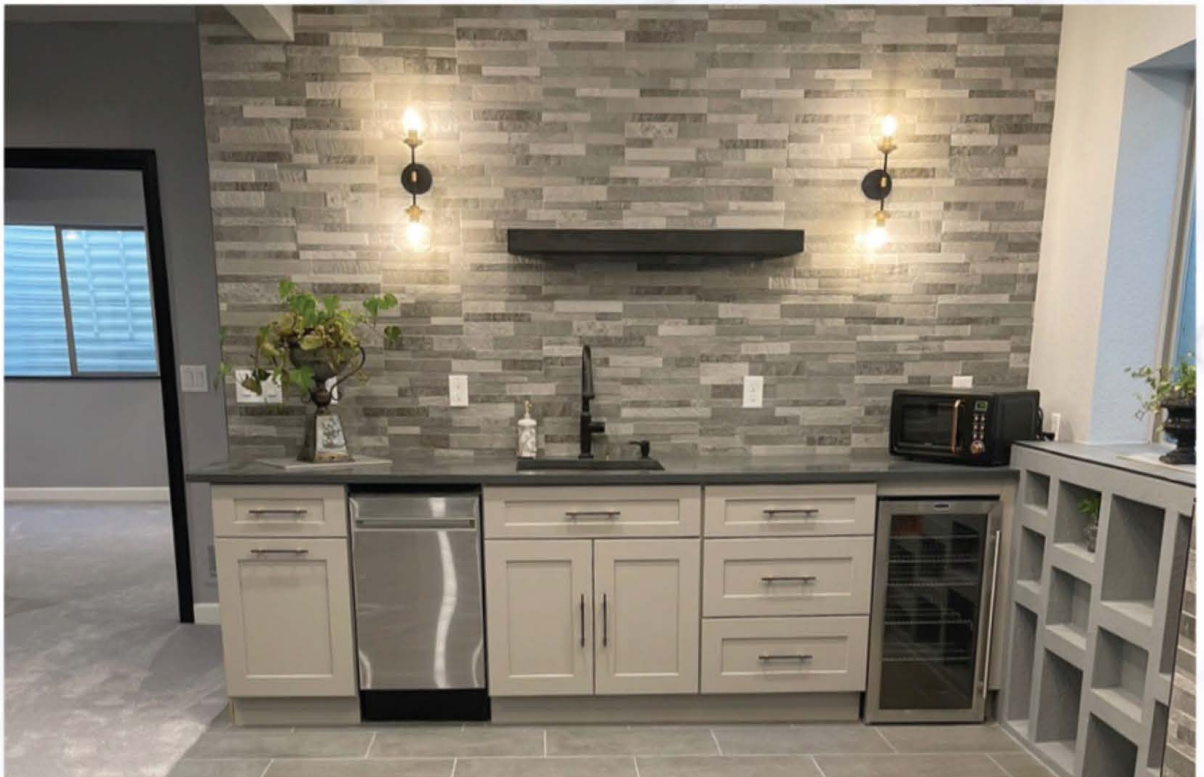

ACCESSORIES

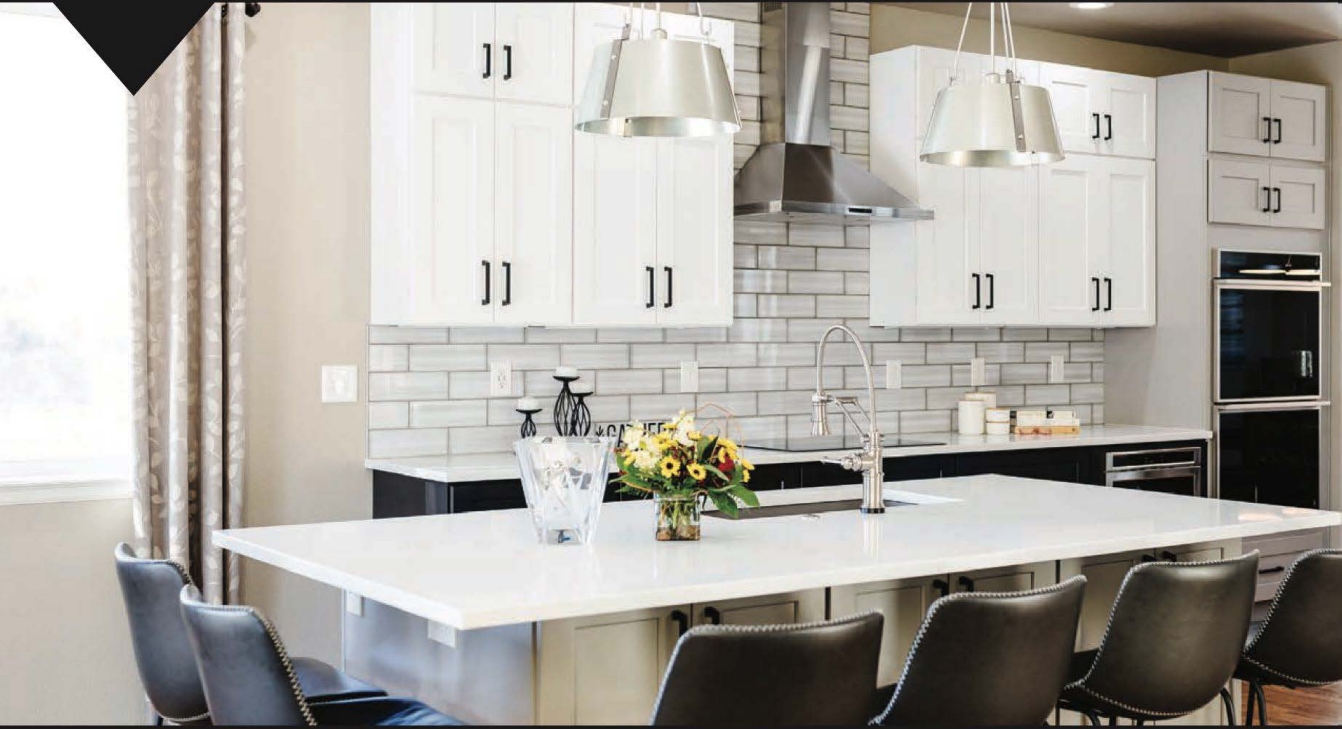

1/4" CABINET SKINS

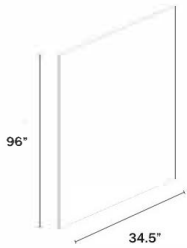

Name	Size	Wt
PNL34.5x96x¼	34.5w x 96h x ¼d	26 lb

Finished: finished skin panel, matching color one side.

1/2" CABINET PANEL

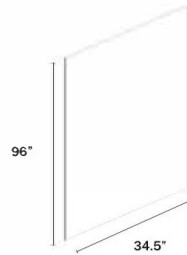

Name	Size	Wt
PNL34.5x96x½	34.5w x 96h x ½d	36 lb

Finished: finished skin panel, matching color both sides.

3/4" CABINET SKINS

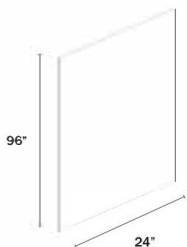

Name	Size	Wt
PNL24x96x¾	24w x 96h x ¾d	30 lb

Finished: finished skin panel, matching color ALL sides.

CABINET FILLERS



Finished: on all sides.

**Comes with ¼" dado for use as a return panel.*

Name	Size
WF330	3w x 30h x ¾d
WF336	3w x 36h x ¾d
WF342	3w x 42h x ¾d
WF630	6w x 30h x ¾d
WF636	6w x 36h x ¾d
WF642	6w x 42h x ¾d
TF1.5x96*	1.5w x 96h x ¾d
TF3x96	3w x 96h x ¾d
TF6x96	6w x 96h x ¾d

BASE FALSE DOOR

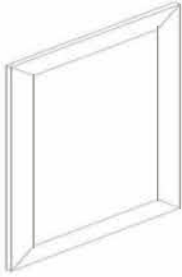

Name	Size
BFD21	20½w x 29¼h x ¾d
BFD24	23½w x 29¼h x ¾d

WALL FALSE DOOR



Name	Size
FD1230	11½w x 29¼h x ¾d
FD1236	11½w x 35¼h x ¾d
FD1242	11½w x 41¼h x ¾d

DISHWASHER RETURN PANEL

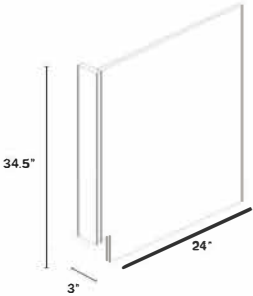

Name	Size	Wt
DWR	24w x 34.5h x 3d	11 lb

Dishwasher panel with 3" return filler

REFRIGERATOR RETURN PANEL

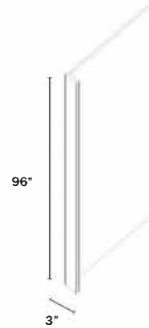

Name	Size	Wt
REP	24w x 96h x 3d	31 lb

BATTEN MOLDING ¾" TALL

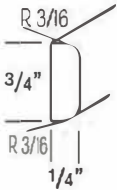

Name	Size
SDM8	96" long

QUARTER ROUND MOLDING ¾" TALL

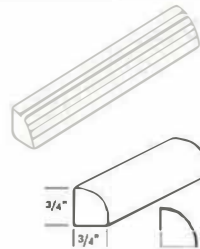

Name	Size
QRMS	96" long

OUTSIDE CORNER MOLDING ¾" TALL

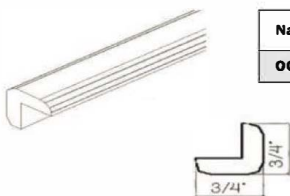

Name	Size
OCM8	96" long

COVE MOLDING ¾" TALL

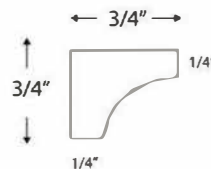

Name	Size
Cove Molding	96" long

BASE MOLDING 4" TALL

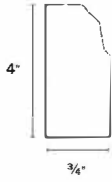

Name	Size
BM8	96" long



TOE KICK 4" TALL



Name	Size
TK8	96" long

SCRIBE MOLDING 3/4" TALL

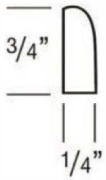

Name	Size
SMB	96" long



LIGHT RAIL MOLDING 1 1/2" TALL

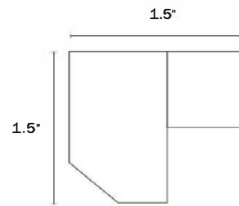

Name	Size
LM8 - S	96" long

SHAKER CROWN MOLDING: 2 1/4" TALL

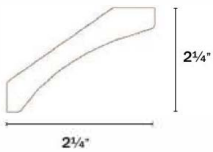

Name	Size
SCM2 1/4	96" long

Available in White, Grey, Modern Slate, Espresso and Signature Blue shaker styles.

SHAKER CROWN MOLDING: 2 1/4" TALL (with heel)

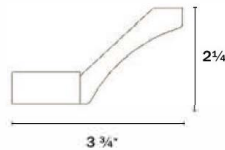

Name	Size
SCM2 1/4 - heel	96" long

Available in White shaker and Espresso shaker styles. Can be painted.

SHAKER CROWN MOLDING: 3 5/8" TALL

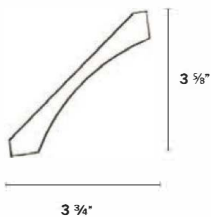

Name	Size
SCM3 5/8	96" long

Available in White, Grey, Modern Slate, Espresso and Signature Blue shaker styles.

SHAKER CROWN MOLDING: 3 5/8" TALL (with heel)

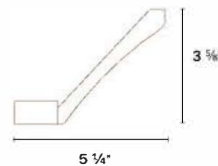

Name	Size
SCM3 5/8 - heel	96" long

Available in White shaker and Espresso shaker styles. Can be painted.

MIRRORS



Name	Size
MIRROR2430	24w x 30h
MIRROR3030	30w x 30h

TURN POST

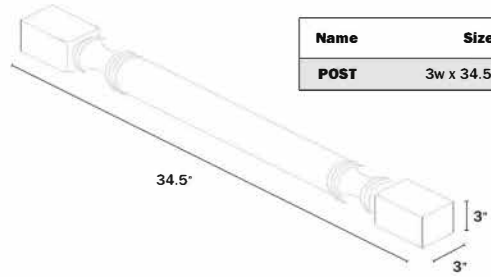

Name	Size
POST	3w x 34.5h x 3d

ROLL OUT TRAYS

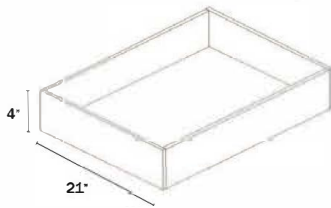

Name	Size
ROT15	15w x 4h x 21d
ROT18	18w x 4h x 21d
ROT21	21w x 4h x 21d
ROT24	24w x 4h x 21d
ROT27	27w x 4h x 21d
ROT30	30w x 4h x 21d
ROT33	33w x 4h x 21d
ROT36	36w x 4h x 21d

Additional installation charge applied.

MISCELLANEOUS ACCESSORIES



**Touch Up Kit
OR Quart of
Custom Paint Color**











HPB HALF PRICE BATHS .COM
BATHROOMS - KITCHENS

WWW.HALFPRICEBATHS.COM